



Carrier

United Technologies

42CET & 42DC Standard Cooling Series
42CED & 42DCD District Cooling Series
60Hz Chilled Water Fan Coil Unit with Electric Heater Option
300~2000 cfm



42CET/ 42CED Series

Chilled Water Fan Coil Unit
Furred-in Ceiling Model
300 to 1400 cfm
Electric heater option

42DC/ 42DCD Series

Chilled Water Fan Coil Unit
Furred-in Ceiling Model
600 to 2000 cfm
Electric heater option



074

The World Leading Air-conditioning Company

DESCRIPTIONS	PAGE
Model Number Nomenclature	2
Features & Benefits	3
Unit Dimensions	4-5
Product Specification	6-7
Performance Data	8-11
Fan Performance	12-19
Electrical Data	20
Wiring Diagrams	21-22
Wiring Diagram Electrical Heater Option	23
Electrical Heater Option	24
Guide Specification	25
Optional	26



FAN COIL SELECTION PROGRAM

Please contact your Carrier's representative for a computer selection program which can help to finalize your selections, based on your "Quick Selection" plus the design parameters of your applications.

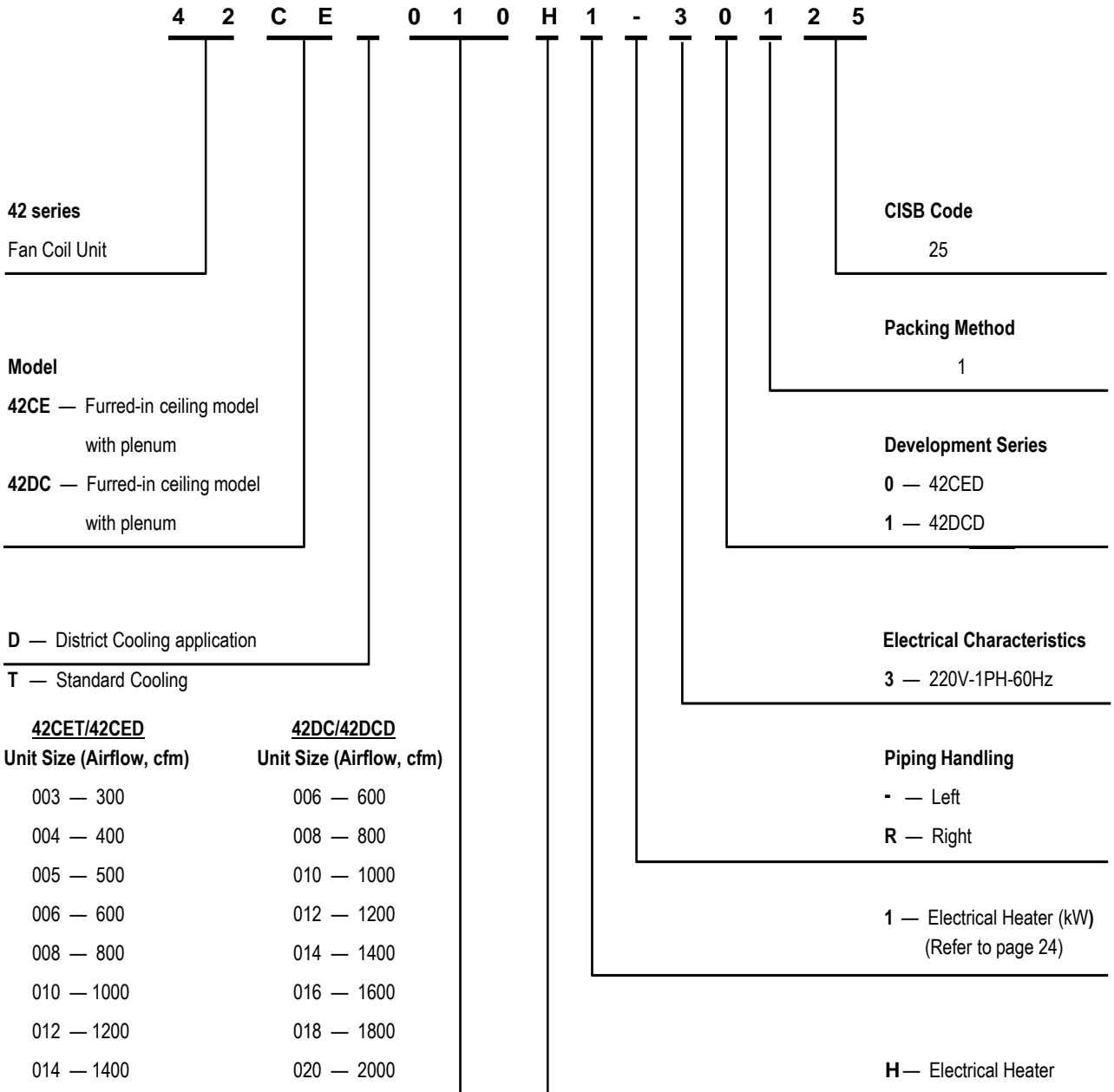

Features & Benefits

With Carrier's 42CET & 42DC Standard Cooling/ 42CED & 42DCD District Cooling Chilled Water Fan Coil Units, furred-in with capacities from 300 to 2000 cfm. Units are ideal for installations in residential, hotels, motels, apartments, offices, hospitals, schools and other multi-room buildings.

Carrier room fan coil terminals provide unsurpassed year round comfort, with high cooling performance. Carrier 42 series terminals requires very little space and is easy to install. Piping, drain and wiring connections are readily accessible to save installation time and field expense.

Forget about expensive ductwork, forget about complex system controls, forget the aggravation and choose Carrier's easy to install room fan coil units – in pipe systems. Opt for quiet, Carrier room fan coil unit operates at exceptionally low sound levels. Generous amount of insulation absorbs operating sound and rugged, rigid construction ensures vibration free operation at all fan speeds.

Carrier room fan coil units are economical. Three speed fans deliver just the right amount of conditioned air for your comfort needs at any load. And each individual unit can be shut off when not in use, Shaded pole motors deliver peak operating efficiency. In choosing Carrier's units, you can match your application with a wide range of custom designed options and accessories.

When you go for Carrier 42 series, the advantages to owner, installer and room occupants are too great to ignore.

Carrier 42CET & 42DC Standard Cooling/ 42CED & 42DCD Series Fan Coil Units give you design and equipment location flexibility

- Wide range of popular capacities, 300 ~ 2000cfm
- Available up to 11 sizes
- Choose from numerous control systems
- Accommodates 2 pipe systems
- Fully insulated, low fan speed means quiet operation
- Draw outside air for odor dilution
- Uses only minimal space
- Electric heating option is available as factory fitted and supply

Select Carrier Fan Coil Units for easy & low cost installation

- Easy wiring, piping connections
- Mounting holes, slots speed hanging
- Requires no expensive ductwork
- Ideal for new construction or renovation

Save operation costs with Carrier's Fan Coil Units

- Individual unit shut-off when not in use
- Efficient, 3-speed centrifugal fans
- Permanent Split Capacitor motors
- High efficiency heat transfer surface

Carrier Fan Coil Units save your service and maintenance expense

- Nationwide Carrier service
- Insulated drain pan
- Easy access to components
- Rugged construction
- Factory leak test for coil
- Cleanable filters
- Long life, heavy duty bearings

Unit Dimensions

42CET/CED Furred-in Ceiling FCU with Plenum

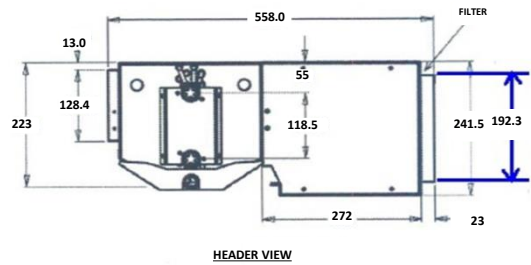
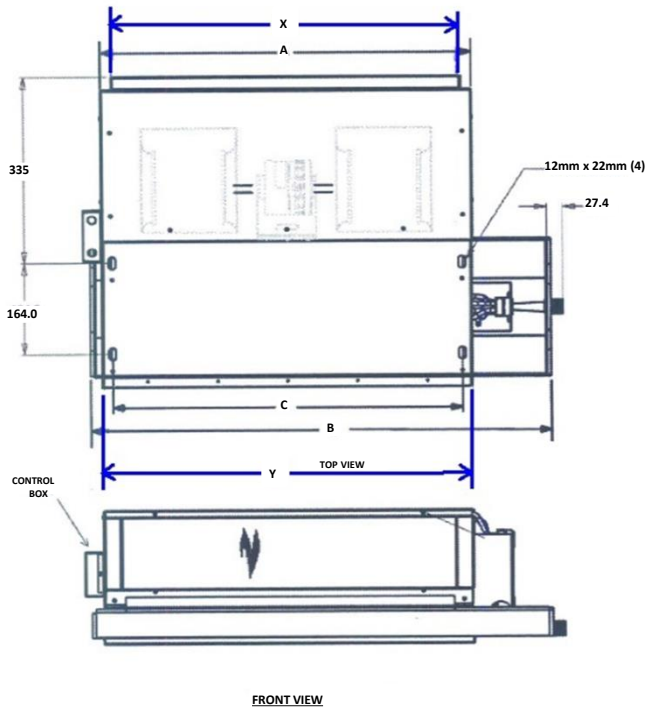

MODEL : 42CET/ 42CED

Unit Sizes	Dimension (mm)					Weight (kg)
	A	B	C	X	Y	
003	636	770	600	599.3	634	17.8
004	756	890	720	719.3	754	20.5
005	836	970	800	799.3	834	21.7
006	1036	1170	1000	919.3	954	23.7
008	1276	1410	1240	1239.3	1274	33.0
010	1396	1530	1360	1359.3	1394	36.7
012	1636	1770	1600	1602	1634	42.0
014	1876	2010	1840	1842	1874	49.1

42DC/DCD Furred-in Ceiling FCU with Plenum

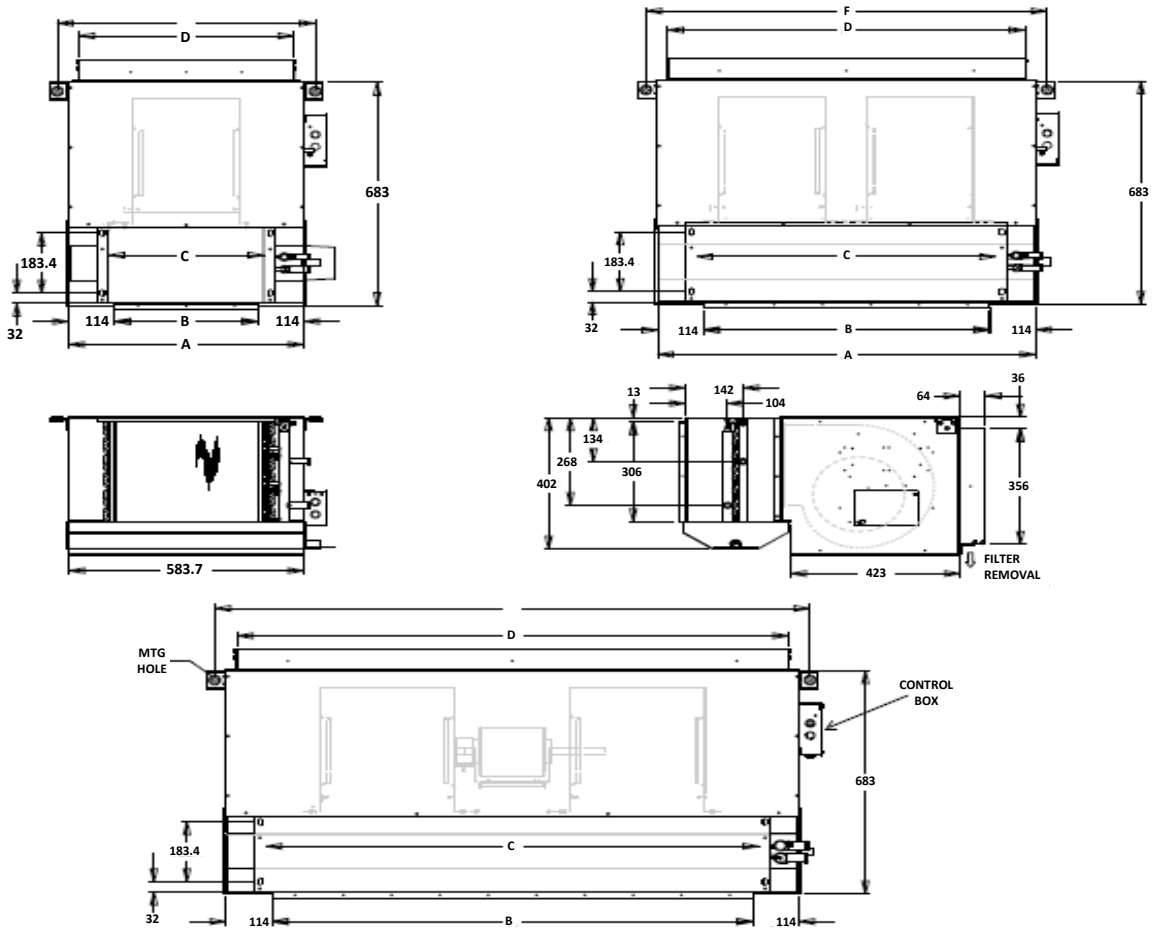

MODEL : 42DC/ 42DCD

Unit Sizes	Dimension (mm)						Weight (kg)
	A	B	C	D	E	F	
006	584	356	381	432	533	641	41
008	711	483	508	559	660	768	46
010	813	584	610	660	762	870	66
012	940	711	737	737	889	997	76
014	1067	838	864	914	1016	1124	78
016	1194	965	991	1041	1143	1251	79
018	1321	1092	1178	1168	1270	1378	86
020	1422	1194	1219	1270	1372	1479	98

Product Specification

Model: 42CED District Cooling Application

Description		DUCTED CHILLED WATER FAN COIL UNIT								
Model		42CED003	42CED004	42CED005	42CED006	42CED008	42CED010	42CED012	42CED014	
Nominal Air Volume	cfm	300	400	500	600	800	1000	1200	1400	
	l/s	142	189	236	283	378	472	566	661	
Fluid Cooling Capacity*	kW	2.21	3.17	3.36	3.61	5.44	5.87	6.41	7.77	
	Btu/hr	7,539	10,823	11,465	12,325	18,551	20,043	21,868	26,505	
Motor	Type	Permanent Split Capacitor								
Motor Nominal Power Output	Watts	30	51	55	52	2 x 46	2 x 55	2 x 52	3 x 48	
Motor Nominal Current	amp	0.36	0.51	0.49	0.52	0.96	0.98	1.04	1.65	
Fan	Type	Centrifugal Forward Curved Blades								
Sound Pressure**	High	dB(A)	37.1	37.4	39.1	40.4	41.3	43.1	43.3	43.5
	Med	dB(A)	34.6	34.9	35.8	38.8	38.8	40.8	39.9	41.8
	Low	dB(A)	33.0	32.1	32.4	35.4	34.6	37.2	37.6	39.8
Water Flow	l/s	0.06	0.09	0.09	0.10	0.15	0.16	0.17	0.21	
Water Pressure Drop	kPa	4.4	10.7	5.9	5.3	12.1	15.2	7.4	12.2	
Coil	Row / FPI	4 / 14								
	Working Pressure	1.72 Mpa								
Connection	In-out (sweat) / Material	¾" FPT (BSP) / Brass								
	Condensate Drain / Material	¾" MPT (BSP) / GI Steel								

Model: 42DCD District Cooling Application

Description		DUCTED CHILLED WATER FAN COIL UNIT								
Model		42DCD006	42DCD008	42DCD010	42DCD012	42DCD014	42DCD016	42DCD018	42DCD020	
Nominal Air Volume	Cfm	600	800	1000	1200	1400	1600	1800	2000	
	l/s	283	378	472	566	661	755	852	943	
Fluid Cooling Capacity*	kW	4.42	6.57	7.43	9.85	10.79	13.69	14.76	15.50	
	Btu/hr	15,076	22,428	25,365	33,597	36,799	46,716	50,362	52,887	
Motor	Type	Permanent Split Capacitor								
Motor Nominal Power Output	Watts	118	118	200	118 (x2)	300	450	450	450	
Motor Nominal Current	Amp	1.11	1.11	1.9	1.11 (x2)	2.24	2.89	2.89	2.89	
Fan	Type	Centrifugal Forward Curved Blades								
Sound Pressure**	High	dB(A)	40.3	42.0	48.4	47.2	49.2	48.6	48.9	49.7
	Med	dB(A)	38.3	38.9	44.8	43.1	46.4	46.9	47.6	48.1
	Low	dB(A)	35.5	36.5	38.6	39.8	44.6	44.8	44.7	45.6
Water Flow	l/s	0.12	0.18	0.20	0.26	0.29	0.37	0.40	0.42	
Water Pressure Drop	kPa	22.2	54.4	46.8	49.9	39.0	50.7	60.2	54.3	
Coil	Row / FPI	4 / 14								
	Working Pressure	1.72 Mpa								
Connection	In-out (sweat)/Material	5/8" / Copper				1" / Copper				
	Condensate Drain/Material	7/8" / GI Steel								

Note:

* Base on motor at high speed, standard air and dry coil operation, 8.9°C water temperature rise; entering air temperature 24.4°C DB; 17.2°C WB, Entering water temperature 5.5°C.

** Sound measurement in accordance with Standard JIS8616-2006 (1.5m below the unit bottom).

Product Specification

Model: 42CET Standard Cooling Application

Description		DUCTED CHILLED WATER FAN COIL UNIT								
Model		42CET003	42CET004	42CET005	42CET006	42CET008	42CET010	42CET012	42CET014	
Nominal Air Volume	cfm	300	400	500	600	800	1000	1200	1400	
	l/s	142	189	236	283	378	472	566	661	
Fluid Cooling Capacity*	kW	2.21	3.17	3.36	3.61	5.44	5.87	6.41	7.77	
	Btu/hr	7,539	10,823	11,465	12,325	18,551	20,043	21,868	26,505	
Motor	Type	Permanent Split Capacitor								
Motor Nominal Power Output	Watts	30	51	55	52	2 x 46	2 x 55	2 x 52	3 x 48	
Motor Nominal Current	amp	0.36	0.51	0.49	0.52	0.96	0.98	1.04	1.65	
Fan	Type	Centrifugal Forward Curved Blades								
Sound Pressure**	High	dB(A)	37.1	37.4	39.1	40.4	41.3	43.1	43.3	43.5
	Med	dB(A)	34.6	34.9	35.8	38.8	38.8	40.8	39.9	41.8
	Low	dB(A)	33.0	32.1	32.4	35.4	34.6	37.2	37.6	39.8
Water Flow	l/s	0.06	0.09	0.09	0.10	0.15	0.16	0.17	0.21	
Water Pressure Drop	kPa	4.4	10.7	5.9	5.3	12.1	15.2	7.4	12.2	
Coil	Row / FPI	4 / 14								
	Working Pressure	1.72 Mpa								
Connection	In-out (sweat) / Material	¾" FPT (BSP) / Brass								
	Condensate Drain / Material	¾" MPT (BSP) / GI Steel								

Model: 42DC Standard Cooling Application

Description		DUCTED CHILLED WATER FAN COIL UNIT								
Model		42DC006	42DC008	42DC010	42DC012	42DC014	42DC016	42DC018	42DC020	
Nominal Air Volume	Cfm	600	800	1000	1200	1400	1600	1800	2000	
	l/s	283	378	472	566	661	755	852	943	
Fluid Cooling Capacity*	kW	4.42	6.57	7.43	9.85	10.79	13.69	14.76	15.50	
	Btu/hr	15,076	22,428	25,365	33,597	36,799	46,716	50,362	52,887	
Motor	Type	Permanent Split Capacitor								
Motor Nominal Power Output	Watts	118	118	200	118 (x2)	300	450	450	450	
Motor Nominal Current	Amp	1.11	1.11	1.9	1.11 (x2)	2.24	2.89	2.89	2.89	
Fan	Type	Centrifugal Forward Curved Blades								
Sound Pressure**	High	dB(A)	40.3	42.0	48.4	47.2	49.2	48.6	48.9	49.7
	Med	dB(A)	38.3	38.9	44.8	43.1	46.4	46.9	47.6	48.1
	Low	dB(A)	35.5	36.5	38.6	39.8	44.6	44.8	44.7	45.6
Water Flow	l/s	0.12	0.18	0.20	0.26	0.29	0.37	0.40	0.42	
Water Pressure Drop	kPa	22.2	54.4	46.8	49.9	39.0	50.7	60.2	54.3	
Coil	Row FPI	4 / 14								
	Working Pressure	1.72 Mpa								
Connection	In-out (sweat)/Material	5/8" / Copper				1" / Copper				
	Condensate Drain/Material	7/8" / GI Steel								

Note:

* Base on motor at high speed, standard air and dry coil operation, 5.6°C water temperature rise; entering air temperature 24.4°C DB; 17.2°C WB, Entering water temperature 7.2°C.

** Sound measurement in accordance with Standard JIS8616-2006 (1.5m below the unit bottom).

Performance Data

Model : 42CED Furred-in Ceiling Model (60Hz motor)									
Unit Sizes	Fan Speed	ESP Pa	Airflow (l/s)	Capacity (kW)		Air Off FCU (°C)		Water Flow (l/s)	Water Pressure (kPa)
				Total	Sensible	DB	WB		
003	High	50	109	3.08	1.81	13.1	10.9	0.08	8.4
	Medium		87	2.73	1.52	12.4	9.8	0.07	6.6
	Low		63	2.09	1.18	11.6	9.3	0.06	3.9
004	High	50	159	4.39	2.62	13.3	11.2	0.12	20.5
	Medium		119	3.73	2.09	12.3	9.8	0.1	14.9
	Low		79	2.65	1.49	11.2	9.0	0.07	7.6
005	High	50	178	4.64	3.08	12.6	11.7	0.12	11.3
	Medium		138	4.01	2.52	11.8	10.7	0.11	8.4
	Low		94	2.88	1.85	10.7	10.2	0.08	4.4
006	High	50	212	5.07	3.37	13.7	12.5	0.14	10.3
	Medium		190	4.77	3.1	13.4	12.0	0.13	9.1
	Low		167	4.44	2.81	13.0	11.6	0.12	8.0
008	High	50	309	7.62	5.18	13.0	12.2	0.21	23.7
	Medium		215	6.13	3.89	11.9	10.9	0.16	15.4
	Low		148	4.44	2.84	11.0	10.3	0.12	8.1
010	High	50	347	8.13	5.46	13.9	12.6	0.22	28.5
	Medium		271	7.01	4.49	13.2	11.8	0.19	21.5
	Low		186	5.08	3.29	12.3	11.3	0.14	11.4
012	High	50	382	8.75	5.78	14.4	12.8	0.24	13.9
	Medium		336	8.14	5.23	14.0	12.3	0.22	12.0
	Low		296	7.28	4.71	13.7	12.2	0.2	9.6
014	High	50	455	10.46	6.95	14.2	12.8	0.28	21.6
	Medium		383	9.44	6.08	13.7	12.2	0.25	17.7
	Low		323	8.13	5.28	13.4	12.0	0.22	13.2

Note:

- Above based on operation with dry coils and clean air filter.
- Rating based on standard air and dry coil operation, 8.9°C water temperature rise; entering air temperature 19.4°C WB / 26.7°C DB, entering water temperature 5.5°C.

Performance Data

Model : 42CET Furred-in Ceiling Model (60Hz motor)

Unit Sizes	Fan Speed	ESP Pa	Airflow (t/s)	Capacity (kW)		Air Off FCU (°C)		Water Flow (t/s)	Water Pressure (kPa)
				Total	Sensible	DB	WB		
003	High	50	109	3.21	1.97	11.9	10.5	0.14	12.1
	Medium		87	2.84	1.66	11.1	9.3	0.12	9.6
	Low		63	2.18	1.28	10.2	8.8	0.09	5.6
004	High	50	159	4.3	2.65	13.1	11.4	0.18	24.3
	Medium		119	3.65	2.11	12.2	10.1	0.16	17.5
	Low		79	2.59	1.51	11.0	9.3	0.11	8.9
005	High	50	178	4.52	2.99	13.0	12.0	0.19	17.2
	Medium		138	3.91	2.45	12.2	11.0	0.17	12.8
	Low		94	2.81	1.8	11.1	10.4	0.12	6.6
006	High	50	212	4.69	3.24	14.2	13.0	0.2	8.3
	Medium		190	4.24	2.97	13.9	12.7	0.19	7.3
	Low		167	4.11	2.69	13.5	12.2	0.18	6.4
008	High	50	309	7.28	5.03	13.4	12.6	0.31	16.1
	Medium		215	5.85	3.78	12.3	11.3	0.25	10.6
	Low		148	4.24	2.76	11.4	10.8	0.18	5.6
010	High	50	347	8.41	5.52	13.7	12.4	0.36	23.3
	Medium		271	7.25	4.55	13.0	11.5	0.31	17.9
	Low		186	5.25	3.33	12.1	11.0	0.22	9.5
012	High	50	382	10.2	6.38	13.1	11.5	0.44	24.5
	Medium		336	9.49	5.77	12.7	11.0	0.41	21.7
	Low		296	8.49	5.2	12.4	10.8	0.36	17.5
014	High	50	455	12.7	7.98	12.4	11.1	0.54	42.2
	Medium		383	11.46	6.97	11.8	10.4	0.49	34.6
	Low		323	9.87	6.06	11.4	10.2	0.42	26.1

Note:

- Above based on operation with dry coils and clean air filter.
- Rating based on standard air and dry coil operation, 5.6°C water temperature rise; entering air temperature 19.4°C WB / 26.7°C DB; entering water temperature 7.2°C.

Performance Data

Model : 42DCD Furred-in Ceiling Model (60Hz motor)									
Unit Sizes	Fan Speed	ESP Pa	Airflow (l/s)	Capacity (kW)		Air Off FCU (°C)		Water Flow (l/s)	Water Pressure (kPa)
				Total	Sensible	DB	WB		
006	High	50	324	6.69	4.81	14.6	13.5	0.18	46.0
	Medium		266	5.89	4.15	13.9	13.0	0.16	37.0
	Low		204	5.01	3.39	13.1	12.2	0.14	28.4
008	High	50	353	7.35	5.52	13.9	13.5	0.2	23.9
	Medium		292	6.52	4.77	13.3	13.0	0.18	19.0
	Low		218	5.49	3.8	12.5	12.0	0.15	13.5
010	High	50	454	8.86	6.83	14.4	13.9	0.24	21.7
	Medium		410	8.29	6.32	14.1	13.7	0.22	19.0
	Low		294	6.87	4.89	13.1	12.6	0.18	13.1
012	High	50	606	11.99	9.13	14.4	13.8	0.32	40.8
	Medium		521	10.88	8.16	13.9	13.5	0.29	33.4
	Low		409	9.38	6.77	13.2	12.8	0.25	26.2
014	High	50	711	13.46	10.44	14.7	14.1	0.36	19.6
	Medium		581	11.82	8.98	14.1	13.6	0.32	15.1
	Low		541	11.28	8.5	13.9	13.5	0.3	13.8
016	High	50	832	15.3	12.02	14.9	14.2	0.41	32.3
	Medium		719	13.94	10.78	14.5	13.9	0.37	27.1
	Low		615	12.6	9.58	14.0	13.6	0.34	22.1
018	High	50	900	16.94	13.18	14.7	14.1	0.45	28.7
	Medium		817	15.92	12.27	14.4	13.9	0.43	26.0
	Low		630	13.55	10.06	13.7	13.2	0.36	18.9
020	High	50	944	18.13	14.02	14.6	14.0	0.49	30.9
	Medium		876	17.25	13.23	14.4	13.8	0.46	28.6
	Low		646	14.37	10.46	13.5	13.0	0.39	19.9

Note:

- Above based on operation with dry coils and clean air filter.
- Rating based on standard air and dry coil operation, 8.9°C water temperature rise; entering air temperature 19.4°C WB / 26.7°C DB, entering water temperature 5.5°C.

Performance Data

Model : 42DC Furred-in Ceiling Model (60Hz motor)

Unit Sizes	Fan Speed	ESP Pa	Airflow (l/s)	Capacity (kW)		Air Off FCU (°C)		Water Flow (l/s)	Water Pressure (kPa)
				Total	Sensible	DB	WB		
006	High	50	324	6.17	4.8	14.6	14.4	0.26	25.5
	Medium		266	5.43	4.14	14.0	13.6	0.23	20.4
	Low		204	4.26	3.38	13.2	12.9	0.2	14.8
008	High	50	353	7.42	5.58	13.8	13.4	0.32	32.3
	Medium		292	6.59	4.82	13.2	12.9	0.28	26.8
	Low		218	5.55	3.84	12.3	11.9	0.24	19.0
010	High	50	454	8.54	6.7	14.6	14.1	0.36	19.4
	Medium		410	7.99	6.2	14.4	13.9	0.34	17.0
	Low		294	6.62	4.8	13.4	12.9	0.28	11.7
012	High	50	606	11.9	8.79	14.9	14.3	0.47	28.5
	Medium		521	10.06	7.85	14.4	13.9	0.43	23.6
	Low		409	8.68	6.51	13.7	13.3	0.37	17.6
014	High	50	711	13.53	10.47	14.7	14.0	0.58	23.1
	Medium		581	11.88	9	14.1	13.6	0.51	18.1
	Low		541	11.34	8.52	13.8	13.4	0.48	16.9
016	High	50	832	16.01	12.41	14.5	14.0	0.68	24.0
	Medium		719	14.58	11.13	14.1	13.6	0.62	20.6
	Low		615	13.18	9.89	13.6	13.3	0.56	17.3
018	High	50	900	18.02	13.72	14.2	13.7	0.77	32.0
	Medium		817	16.94	12.77	13.9	13.5	0.72	28.1
	Low		630	14.42	10.47	13.1	12.8	0.62	22.1
020	High	50	944	19.5	14.75	13.9	13.5	0.83	35.9
	Medium		876	18.55	13.92	13.7	13.4	0.79	33.3
	Low		646	15.46	11.01	12.8	12.4	0.66	23.9

Note:

- Above based on operation with dry coils and clean air filter.
- Rating based on standard air and dry coil operation, 5.6°C water temperature rise; entering air temperature 19.4°C WB / 26.7°C DB, entering water temperature 7.2°C.

Fan Performance

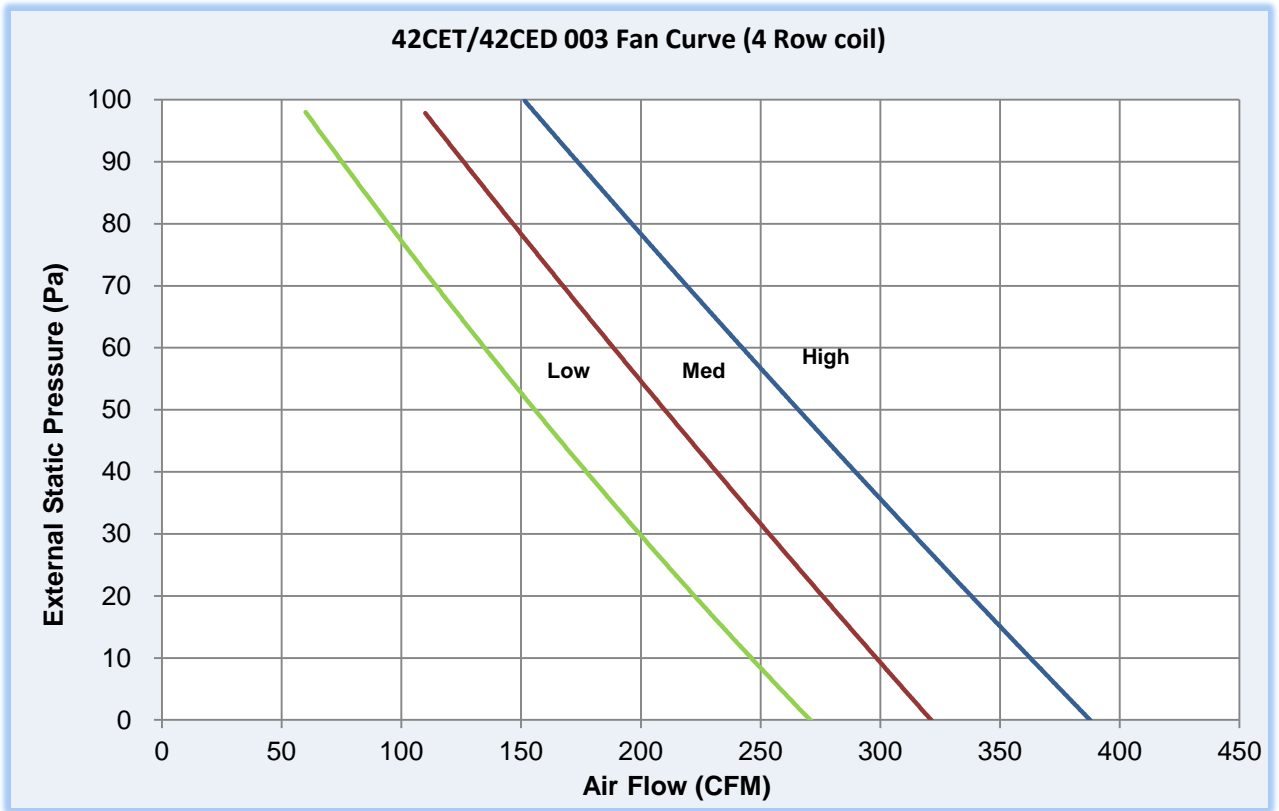

*Note: Dry coil

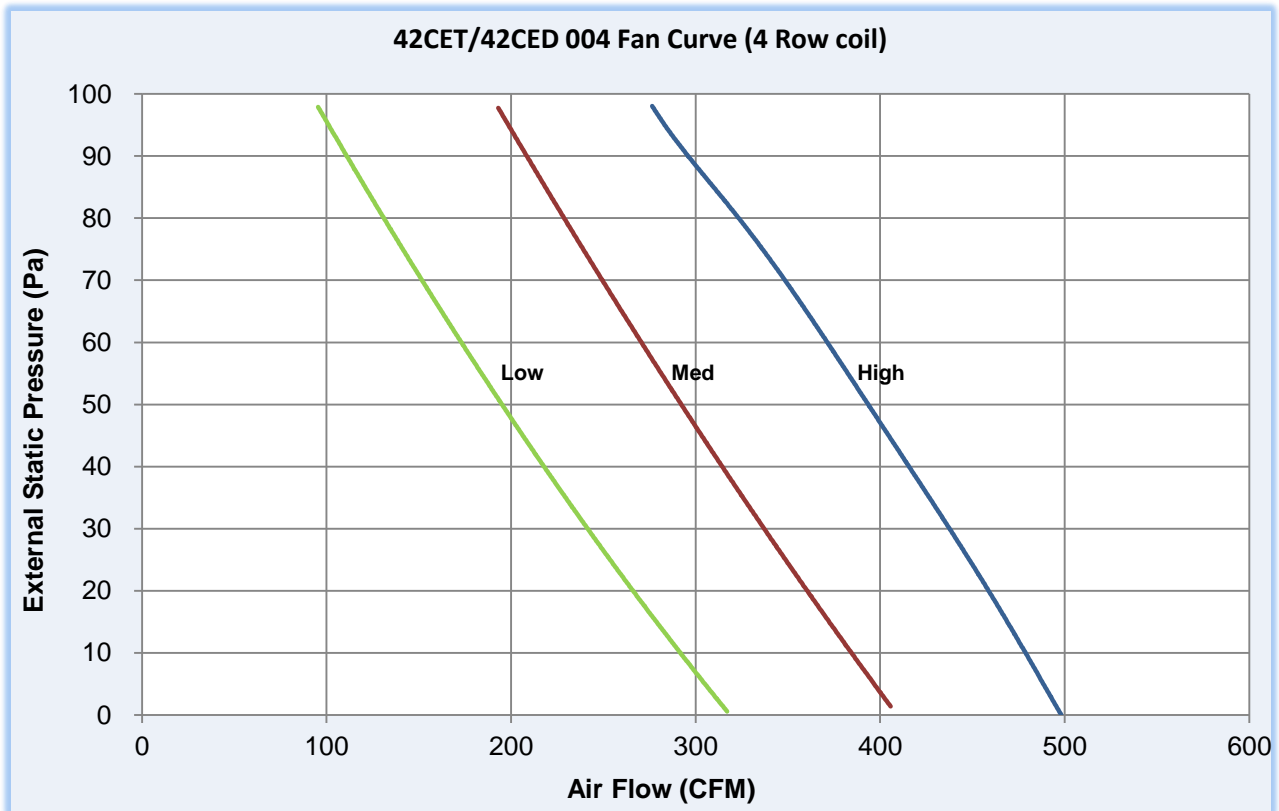

*Note: Dry coil

Fan Performance

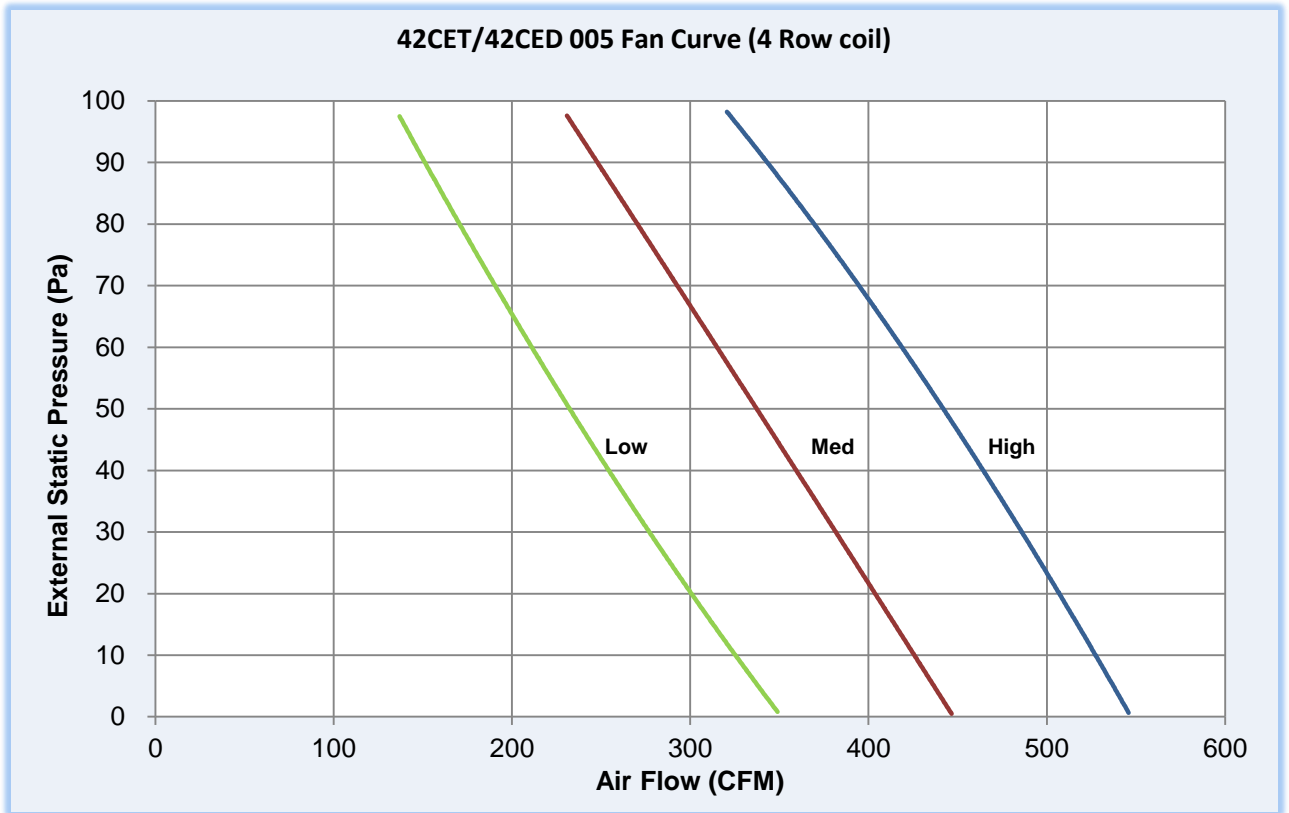

*Note: Dry coil

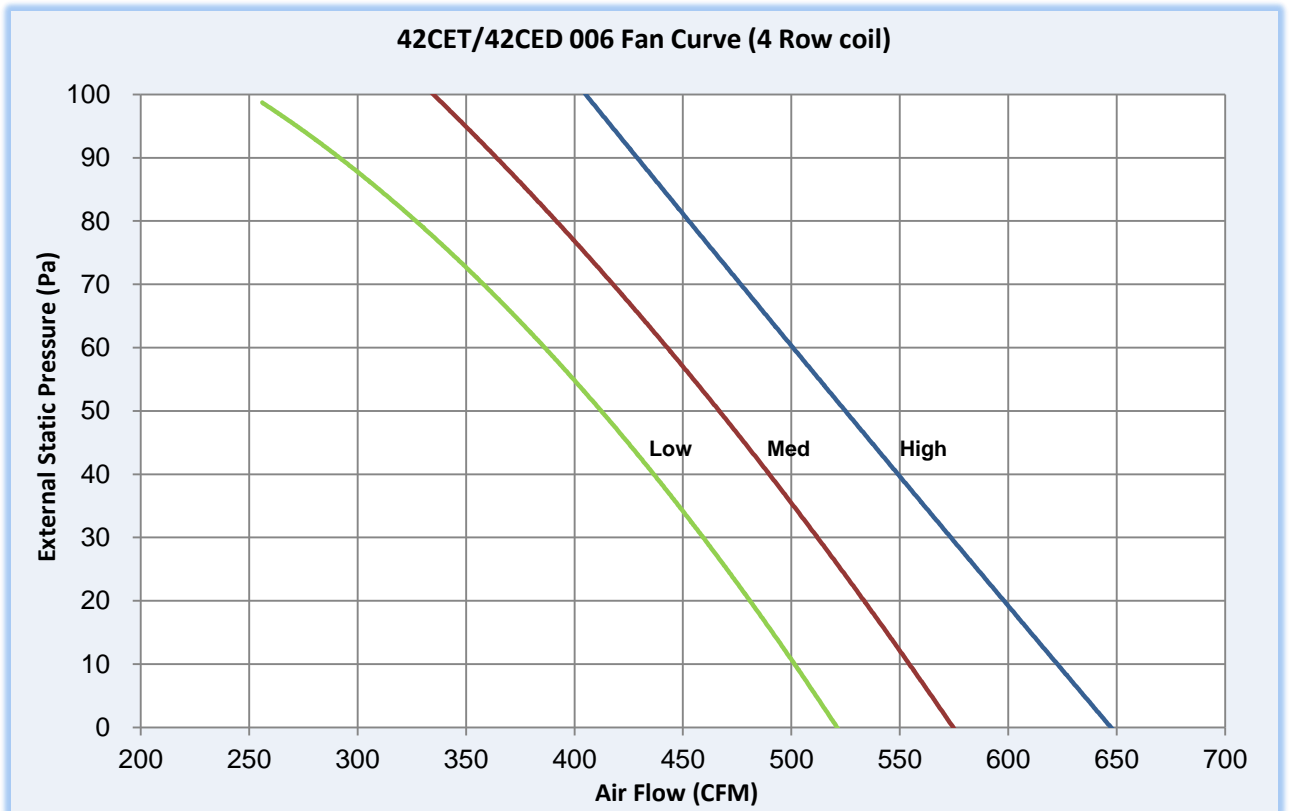

*Note: Dry coil

Fan Performance

42CET/42CED 008 Fan Curve (4 Row coil)

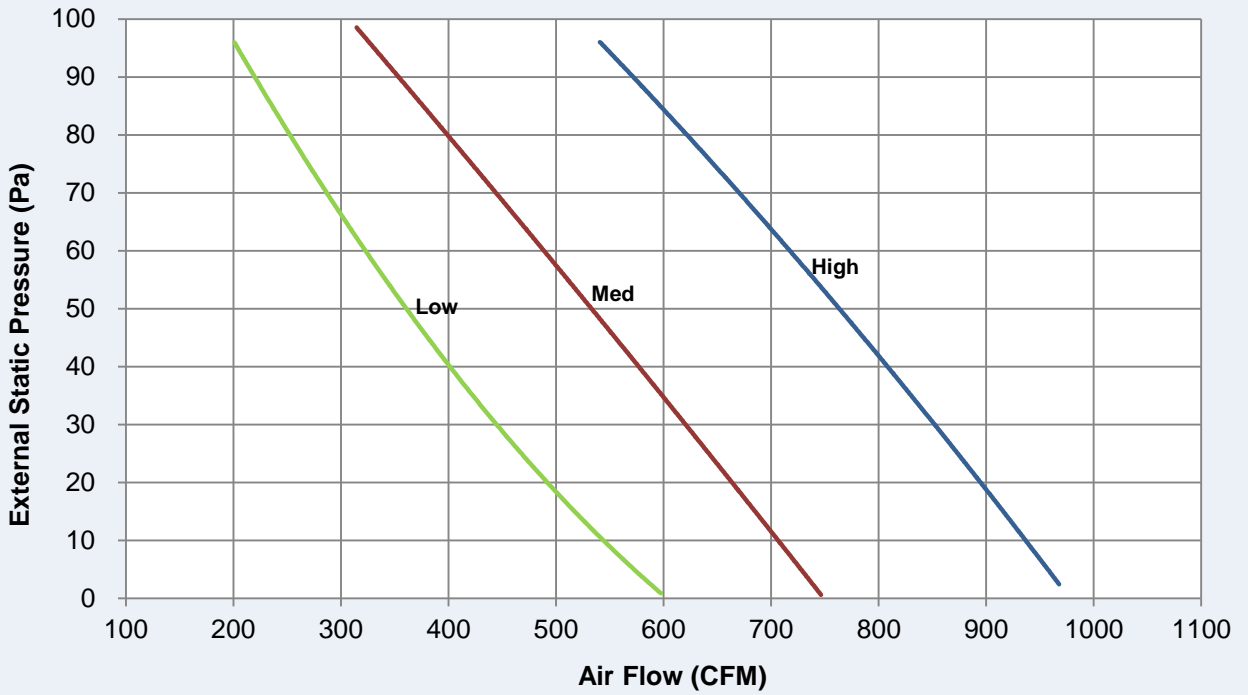

*Note: Dry coil

42CET/42CED 010 Fan Curve (4 Row coil)

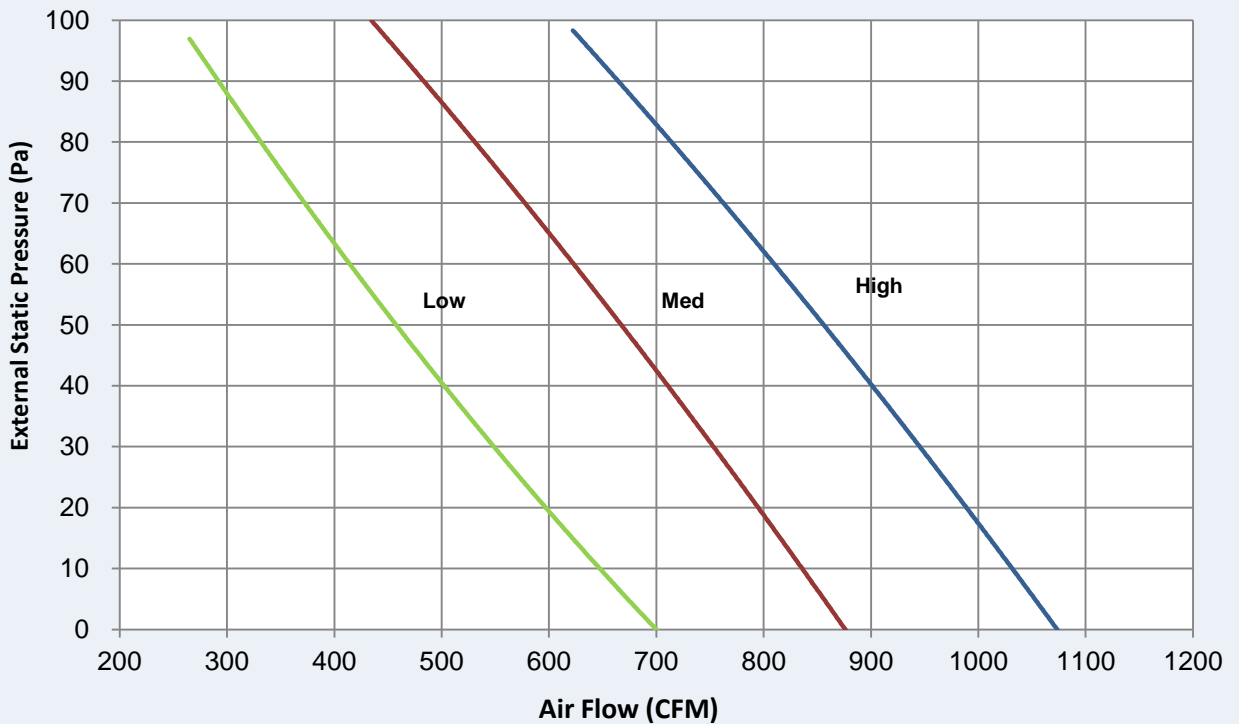

*Note: Dry coil

Fan Performance

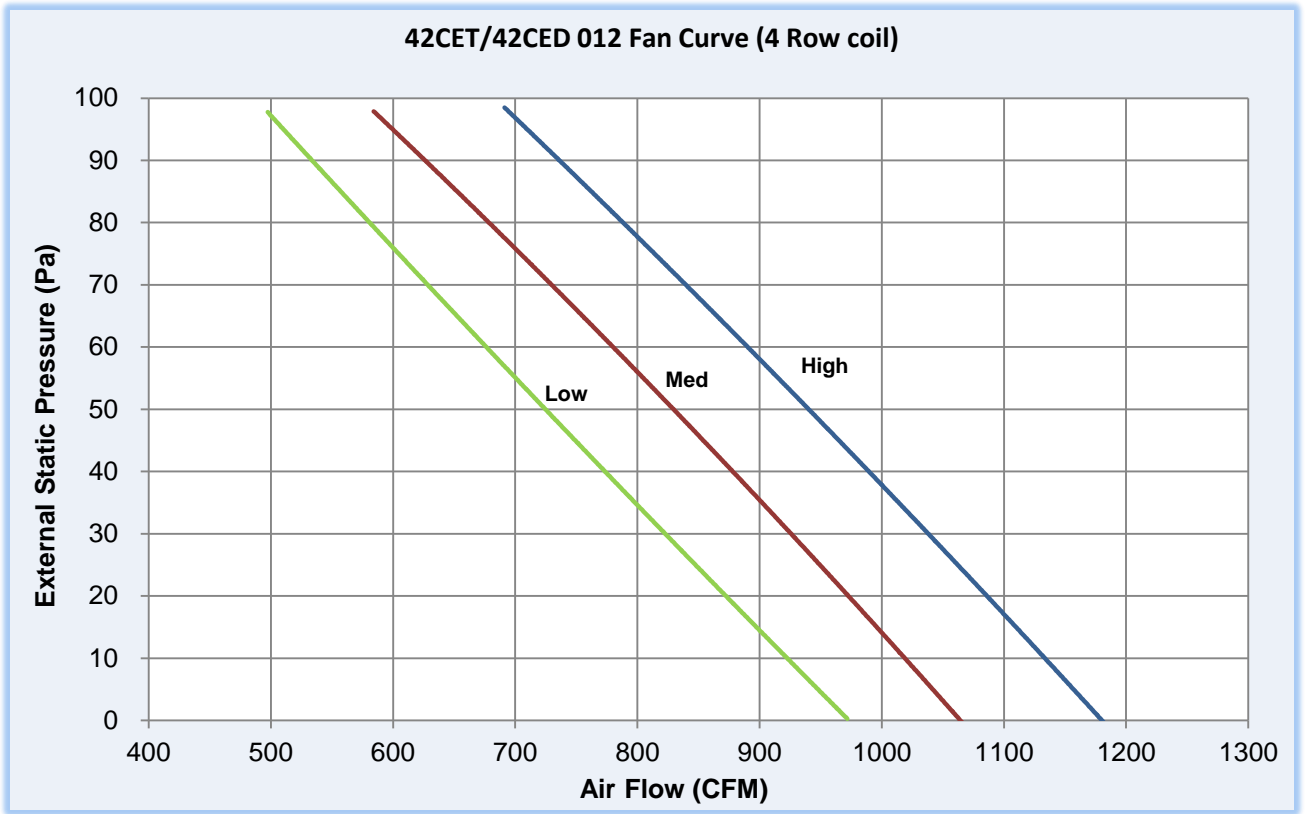

**Note: Dry coil*

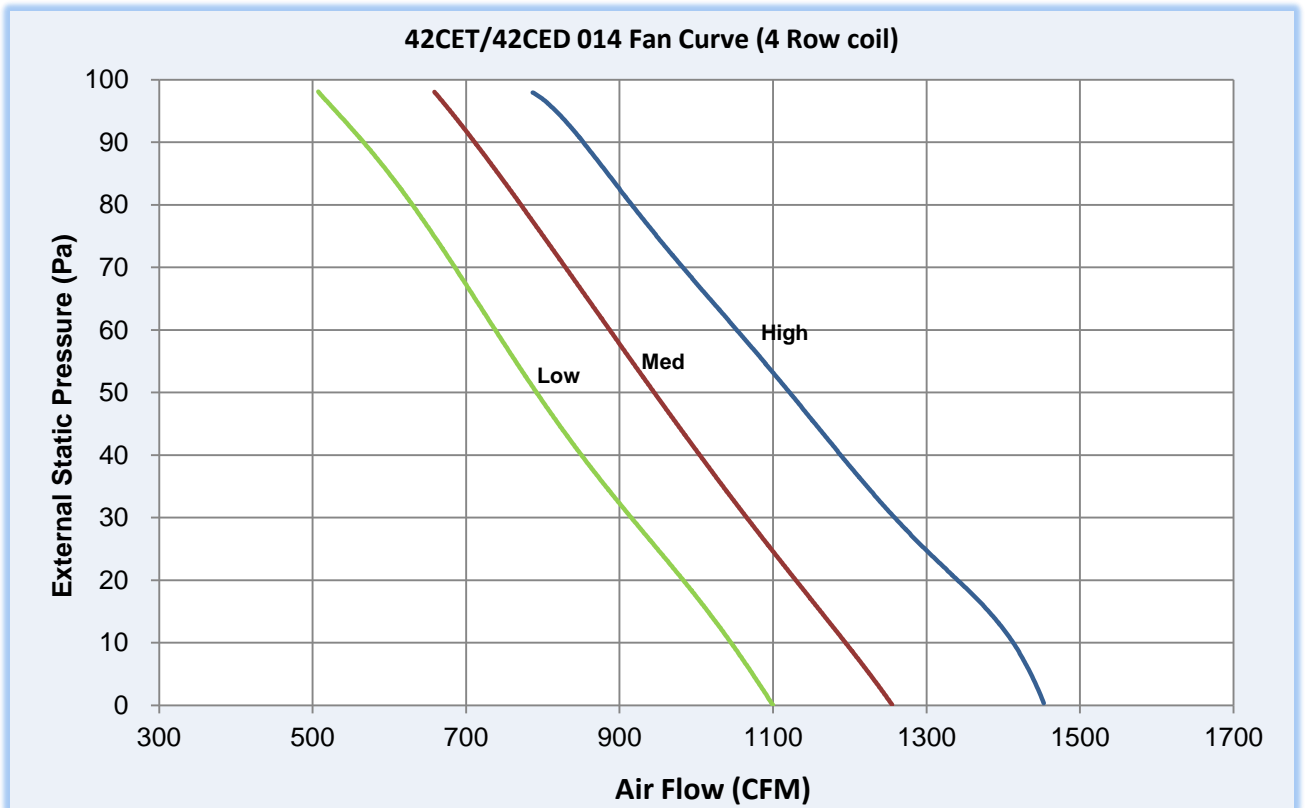

**Note: Dry coil*

Fan Performance

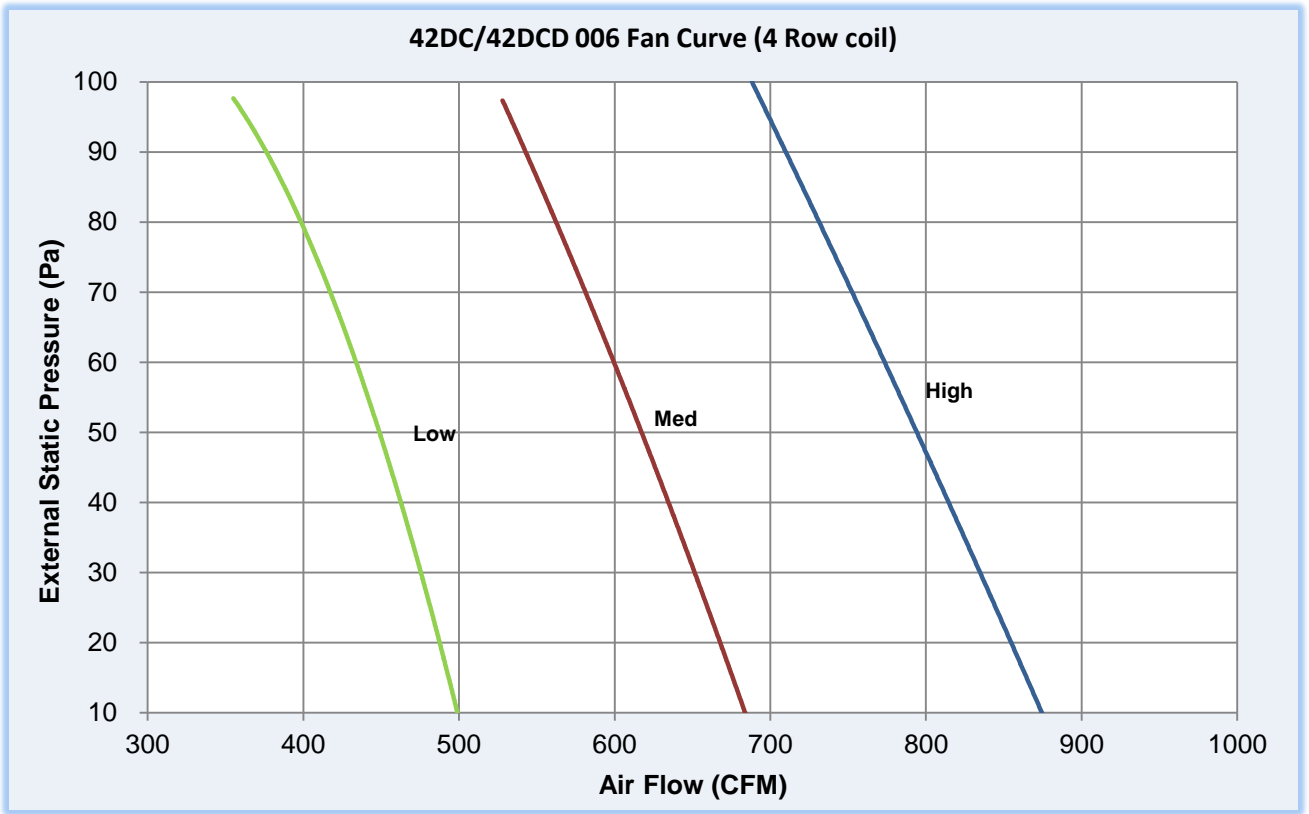

**Note: Dry coil*

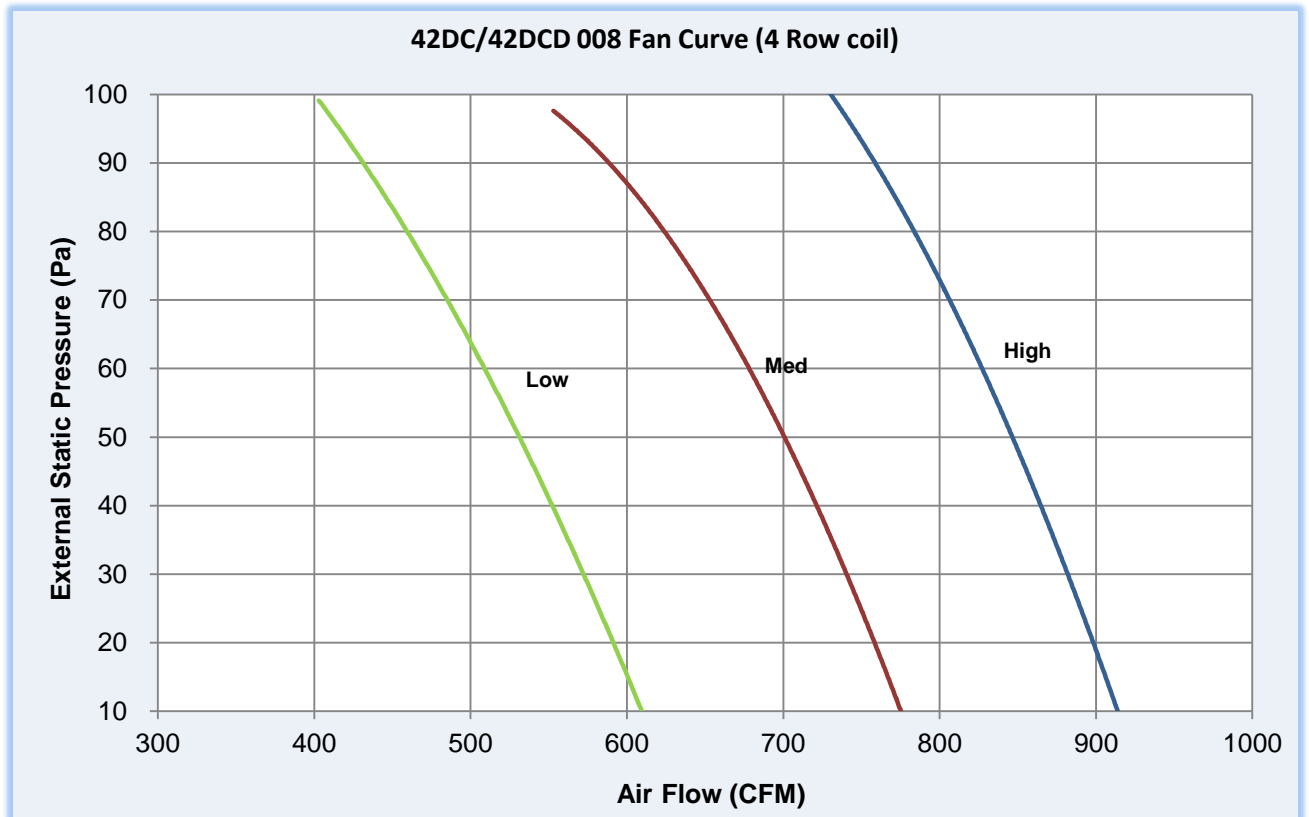

**Note: Dry coil*

Fan Performance

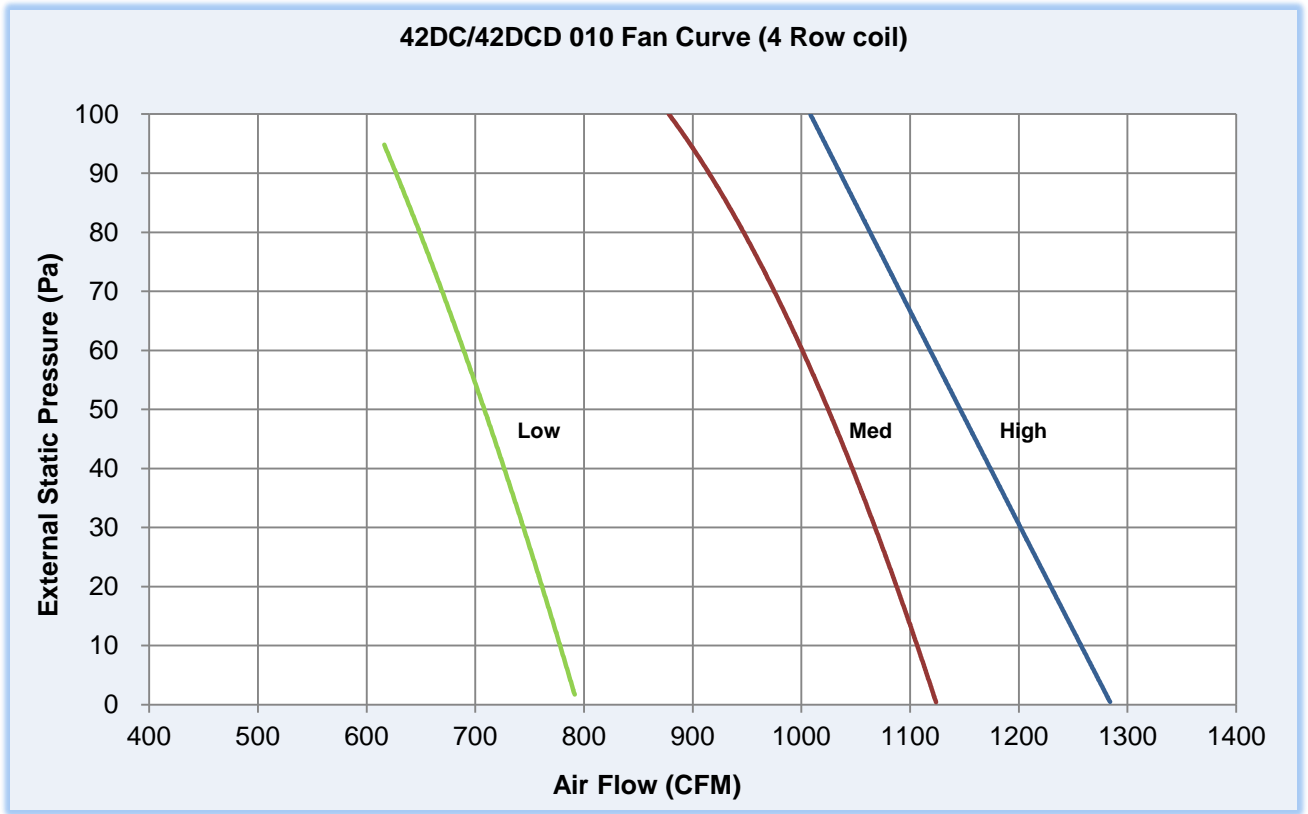

**Note: Dry coil*

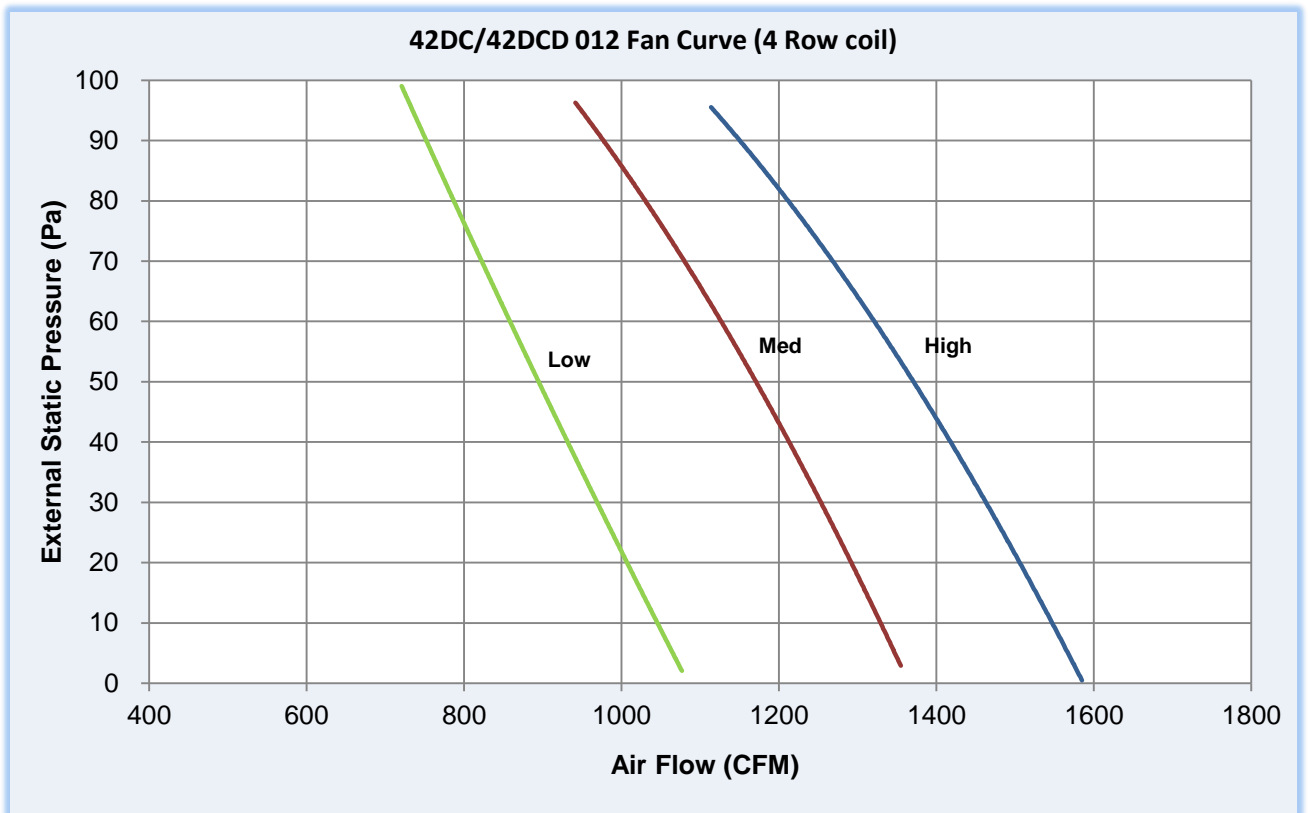

**Note: Dry coil*

Fan Performance

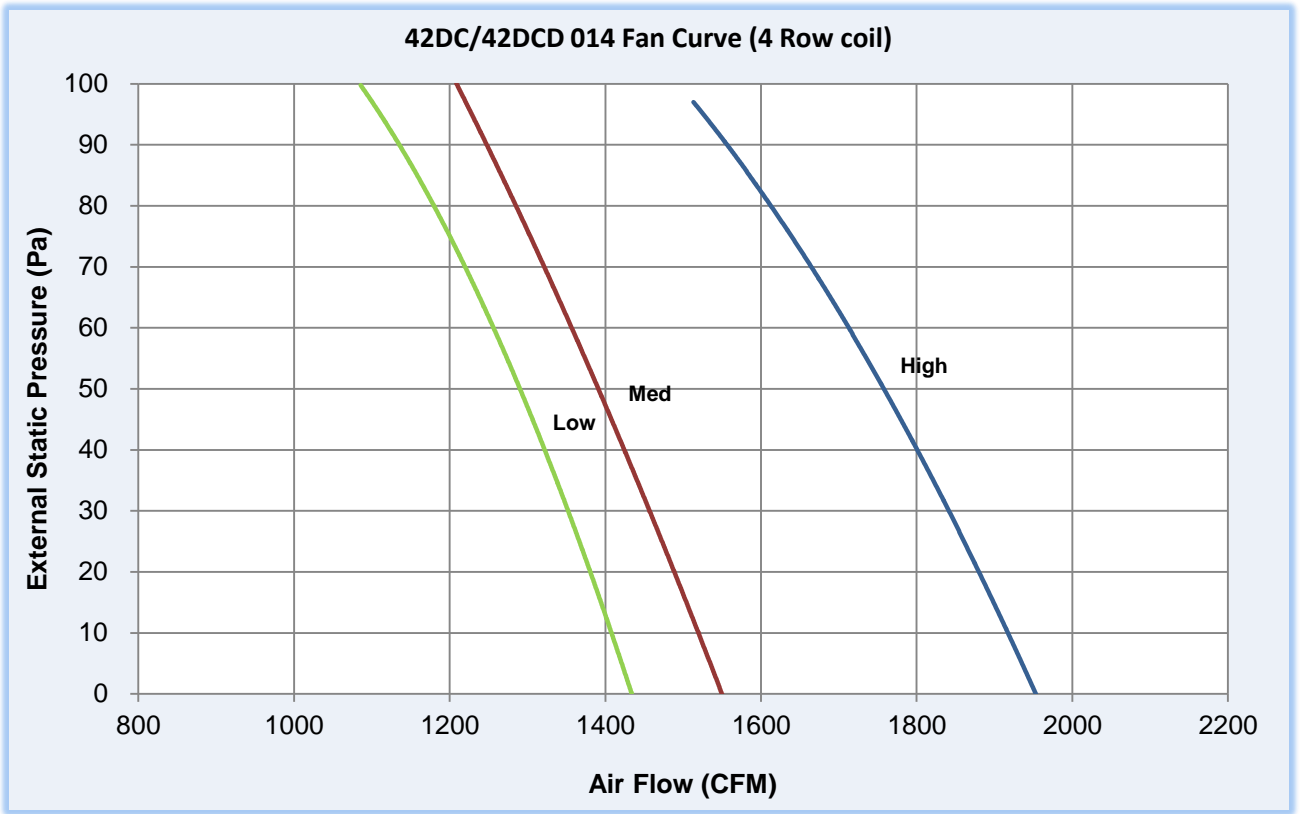

**Note: Dry coil*

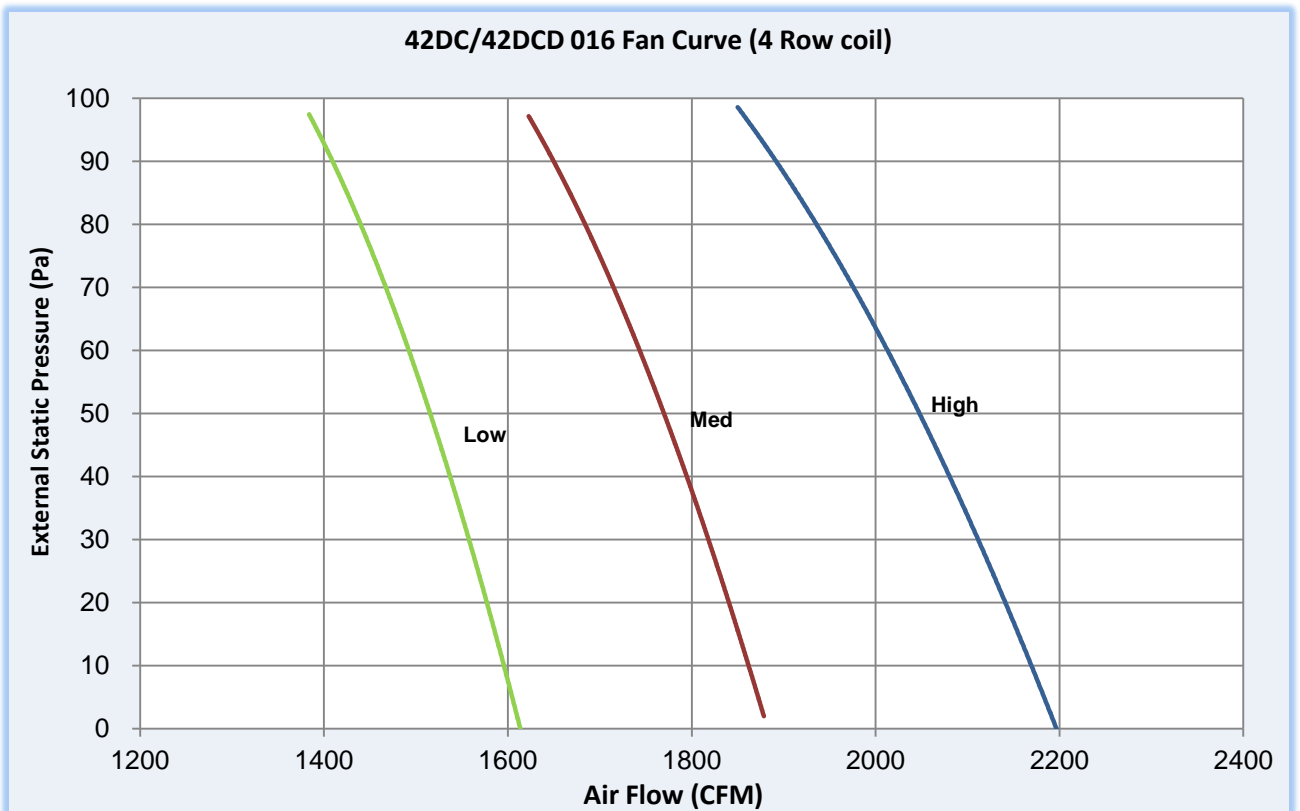

**Note: Dry coil*

Fan Performance

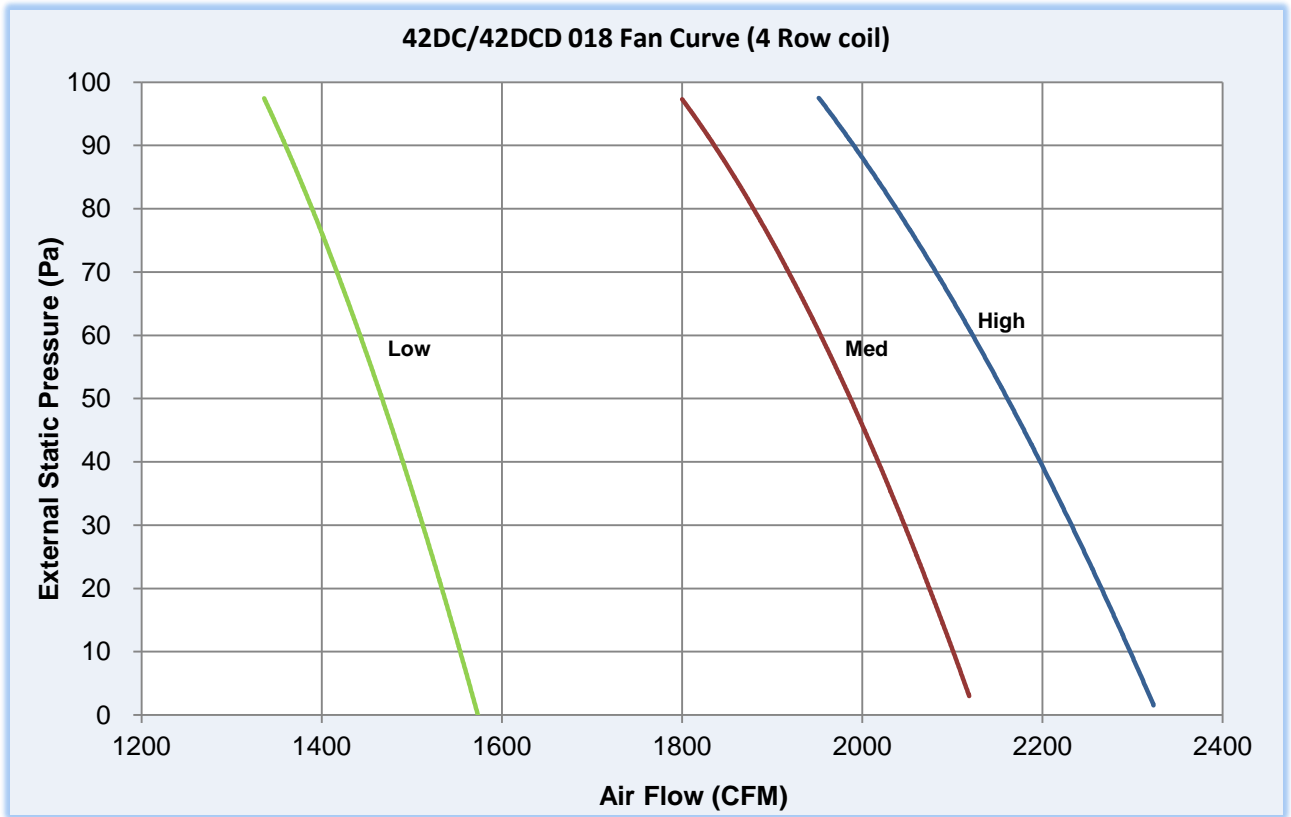

*Note: Dry coil

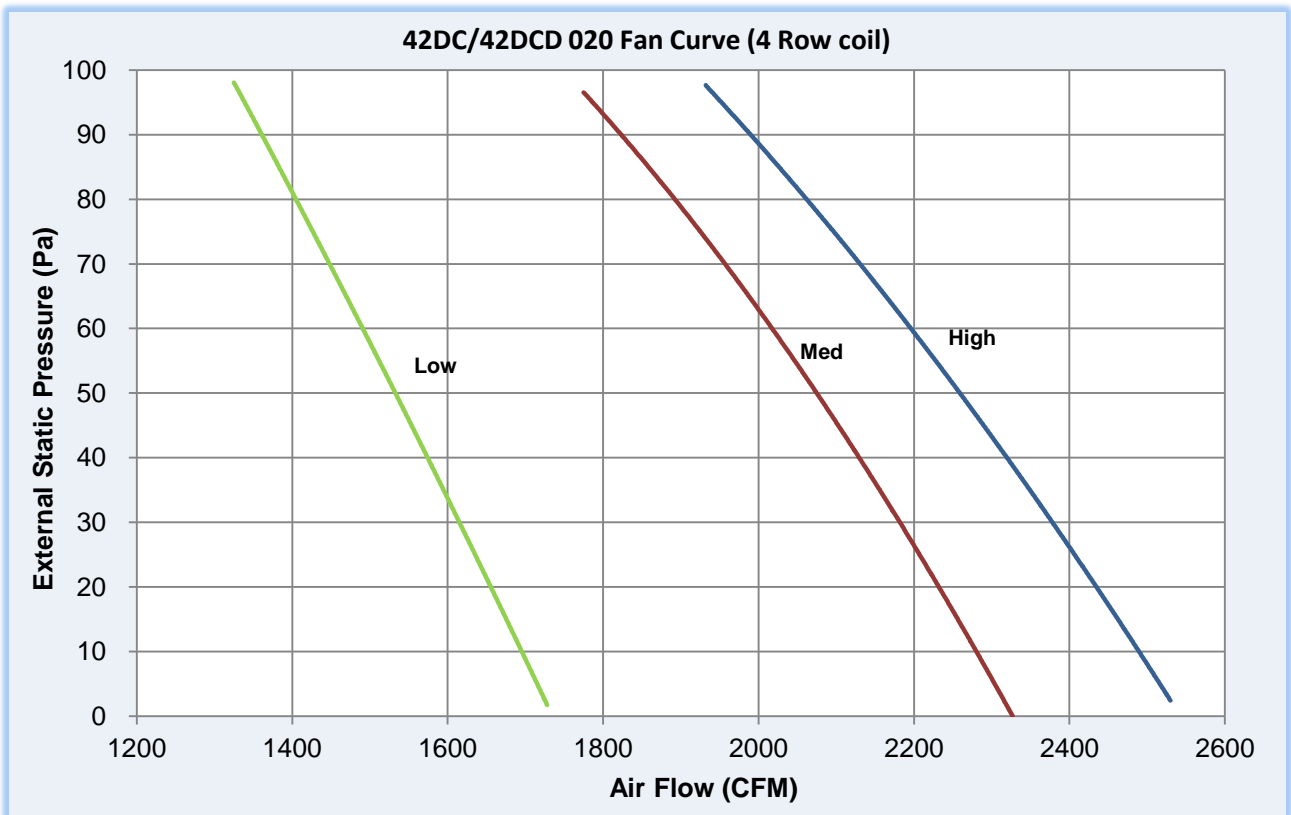

*Note: Dry coil

42CET/42CED 60Hz Motor Data

		42CET/42CED 003			42CET/42CED 004			42CET/42CED 005			42CET/42CED 006		
Speed	RPM	Nominal Power Output	Watts	Amps	Nominal Power Output	Watts	Amps	Nominal Power Output	Watts	Amps	Nominal Power Output	Watts	Amps
High	1320	30W	61	0.27	45W	82	0.36	70W	97	0.42	72W	114	0.50
Medium	1190		49	0.23		70	0.32		82	0.37		93	0.42
Low	1080		40	0.19		61	0.29		72	0.33		84	0.38

		42CET/42CED 008			42CET/42CED 010			42CET/42CED 012			42CET/42CED 014		
Speed	RPM	Nominal Power Output	Watts	Amps	Nominal Power Output	Watts	Amps	Nominal Power Output	Watts	Amps	Nominal Power Output	Watts	Amps
High	1320	55W (x2)	163	0.71	70W (x2)	189	0.83	72W (x2)	261	1.20	70W (x3)	297	1.32
Medium	1190		135	0.61		154	0.68		219	0.96		262	1.14
Low	1080		114	0.53		129	0.46		190	0.84		235	1.04

Note: Motor nameplate amps may vary.

42DC/42DCD 60Hz Motor Data

		42DC/42DCD 006			42DC/42DCD 008			42DC/42DCD 010			42DC/42DCD 012		
Speed	RPM	Nominal Power Output	Watts	Amps	Nominal Power Output	Watts	Amps	Nominal Power Output	Watts	Amps	Nominal Power Output	Watts	Amps
High	1000	120W	225	1.14	120W	227	1.15	200W	502	2.10	120W (x2)	528	2.58
Medium	870		141	0.68		142	0.68		418	1.75		302	1.34
Low	750		107	0.53		109	0.54		283	1.19		239	1.06

		42DC/42DCD 014			42DC/42DCD 016			42DC/42DCD 018			42DC/42DCD020		
Speed	RPM	Nominal Power Output	Watts	Amps	Nominal Power Output	Watts	Amps	Nominal Power Output	Watts	Amps	Nominal Power Output	Watts	Amps
High	1000	300W	631	2.92	450W	710	3.23	450W	756	3.47	450W	796	3.62
Medium	870		459	2.11		588	2.70		701	3.20		712	3.25
Low	750		402	1.84		498	2.28		506	2.31		510	2.36

Note: Motor nameplate amps may vary.

42CET/CED Wiring Diagram

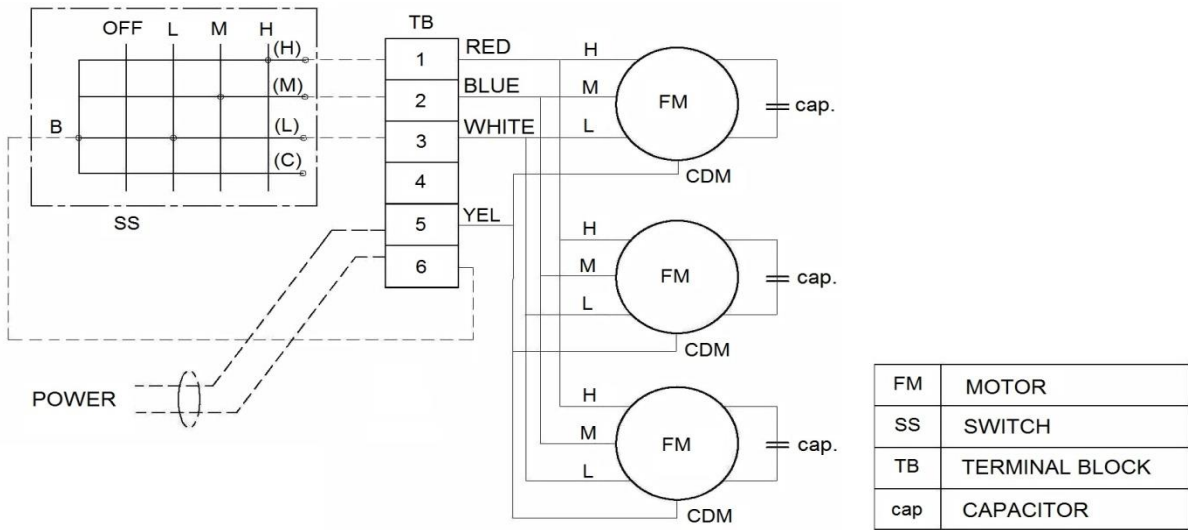

- Note:**
- 1.) CAUTION! Disconnect power before servicing.
 - 2.) Use 14 AWG, 75°C MIN, copper conductor.
 - 3.) Motor(s) thermally protected.
 - 4.) Provide disconnect means and over current protection as required.
 - 5.) 42CET/42CED 003 to 006 are single motor, 42CET/42CED 008 to 012 are double motor & 014 is three motors.
 - 6.) Snap apart carefully at hinge to separate cover from the control box.

42DC/42DCD 006~012 Wiring Diagram

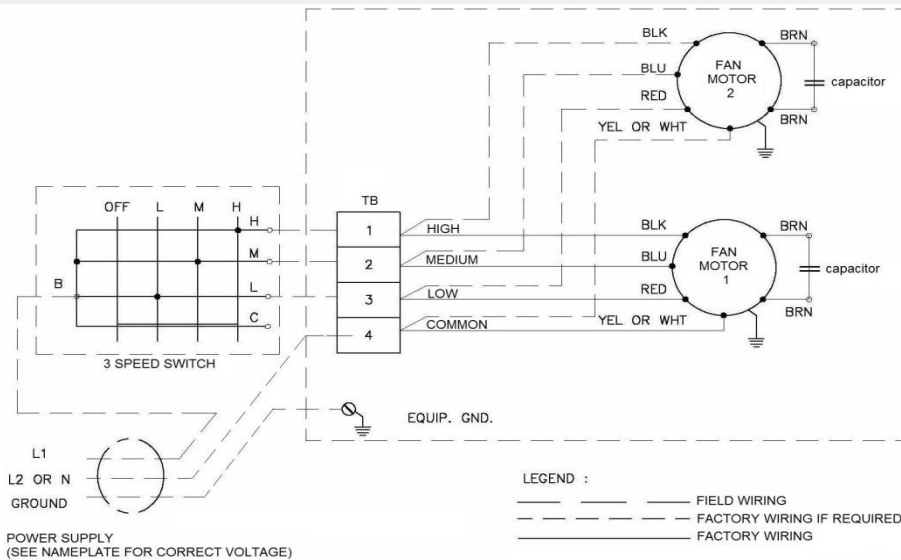

- Note:**
- 1.) CAUTION! Disconnect power before servicing.
 - 2.) Use 14 AWG, 75°C MIN, copper conductor.
 - 3.) Motor(s) thermally protected.
 - 4.) Provide disconnect means and over current protection as required.
 - 5.) 42DC/42DCD 012 and above have two fan motors.

42DC/42DCD 014 ~ 020 Wiring Diagram

MODEL	FAN MOTOR SPEED USED / COLOR			
	HIGH	MEDIUM	LOW	UNUSED
42DC/42DCD 014	RED	BROWN	ORANGE	YELLOW
42DC/42DCD 016	YELLOW	BROWN	ORANGE	RED
42DC/42DCD 018	RED	YELLOW	ORANGE	BROWN
42DC/42DCD 020	RED	YELLOW	ORANGE	BROWN

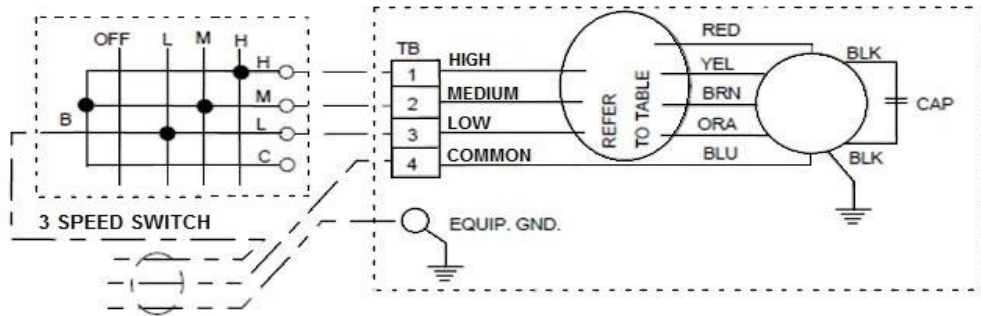

LEGEND:

- FIELD WIRING
- FACTORY WIRING IF REQUIRED
- FACTORY WIRING

- Note:**
- 1.) CAUTION: Disconnect power before servicing.
 - 2.) Use 14 AWG, 75°C MIN, copper conductor.
 - 3.) Motor(s) thermally protected.
 - 4.) Provide disconnect means & over current protection as required.
 - 5.) Unit 42DC/42DCD 014 and above have 2 fan motors.

Wiring Diagram With Heater

42CET/CED 003~012 & 42DC/DCD 006~012

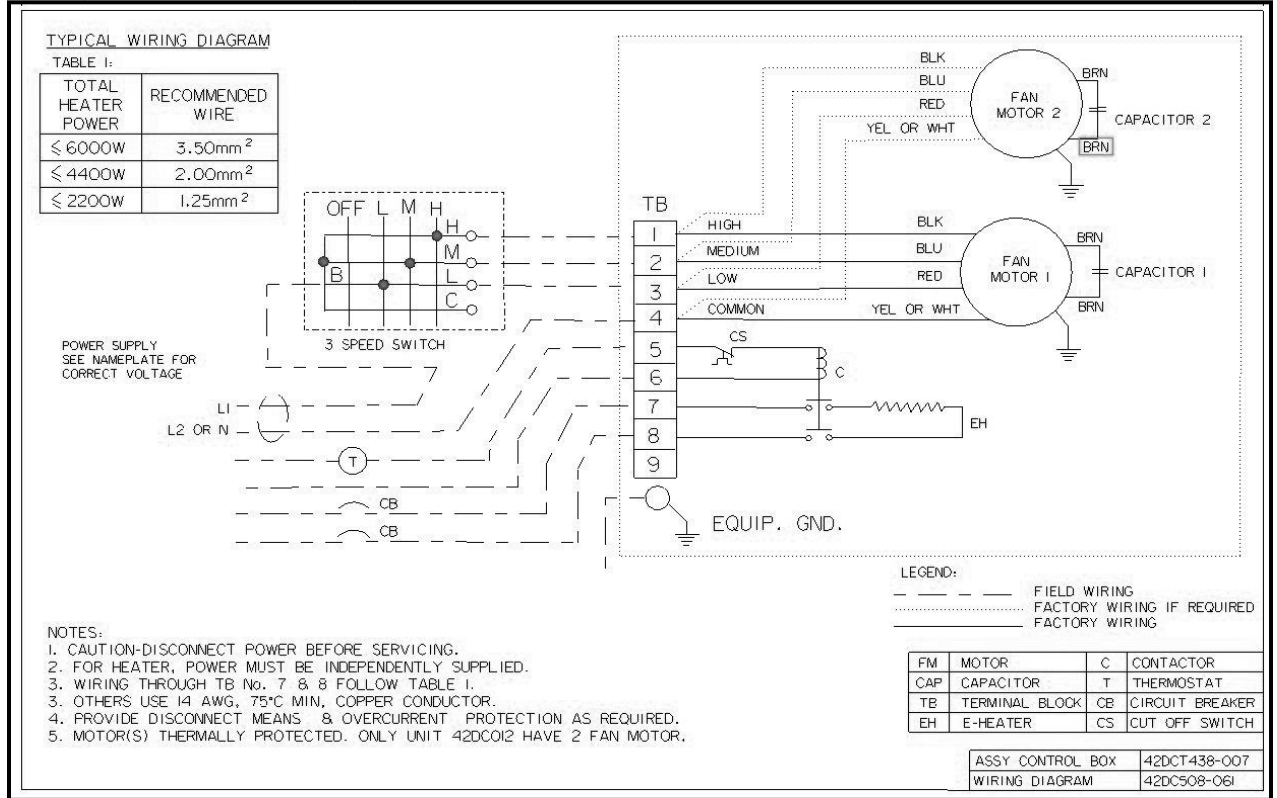

42CET/CED 014 & 42DC/DCD 014~020

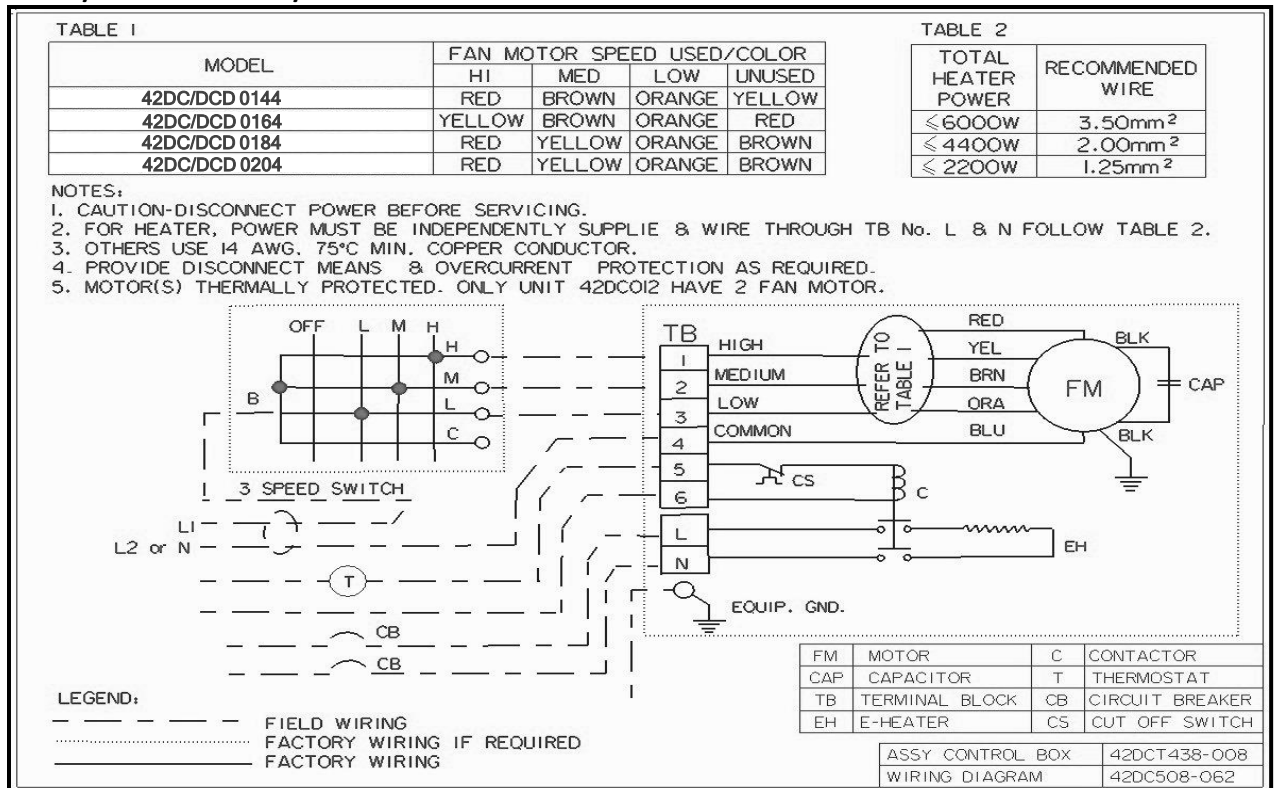

Electrical Heater Option

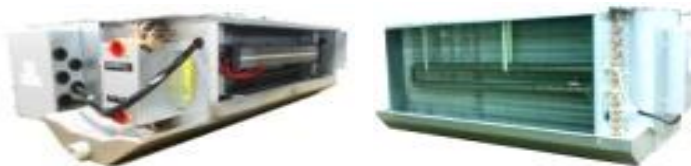

42C/42D WITH ELECTRICAL HEATER DATA

Model no	Product Name	Nominal size	Heating kW	Power Supply
42CED003H--30125	42CED & 42CET	003	1.2	230V-1PH-60Hz
42CED004H--30125		004	1.5	
42CED005H--30125		005	1.8	
42CED006H--30125		006	2.2	
42CED008H--30125		008	2.4	
42CED010H--30125		010	3	
42CED012H--30125		012	3.6	
42CED014H--30125		014	4.4	
42DCD006H1-32125		42DCD & 42 DC	006	
42DCD008H2-32125	008		2	
42DCD010H3-32125	010		3	
42DCD012H3-32125	012		3	
42DCD012H4-32125	012		4	
42DCD014H4-32125	014		4	
42DCD014H5-32125	014		5	
42DCD016H4-32125	016		4	
42DCD016H5-32125	016		5	
42DCD018H5-32125	018		5	
42DCD018H6-32125	018		6	
42DCD020H5-32125	020		5	
42DCD020H6-32125	020		6	

Note:

42DC/42DCD size 012 to size 020 are offered with 2 sets of heating kW

SPECIFICATIONS

Product Name	Electric heater specifications
42CED	<p>Fin type : Aluminum</p> <p>Construction: PTC type electric heater.</p> <p>Heater Mounting: Bracket with PPS material to hold on both sides of the heater.</p> <p>Wires: Heater wires are protected with PPS material and pre-wires to the heater.</p> <p>Over temperature cut off switch as a protection device.</p>
42DCD	<p>Fin type : Stainless Steel SUS304</p> <p>Construction: Continuous spiral stainless steel fins SUS304 brazed to 8 mm diameter steel sheathed tubular element diameter over fin 28.5mm & fin pitch 5mm.</p> <p>Heater mounting : Mounting holes: 22mm diameter</p> <p>Wires: Heater wires are fully insulated with fiberglass & pre-wires to the heater.</p> <p>Over temperature cut off switch as a protection device</p>

HVAC GUIDE SPECIFICATIONS

Size Range: 300 to 2000 nominal cfm

Part 1 – GENERAL

1.1 System Description

Horizontal, furred-in, above ceiling for ducting room fan coil unit.

1.2 Quality Assurance

Unit shall be tested in accordance with ARI Standard 440. Each coil shall be factory tested for leakage at 400 psig air pressure with coil submerged in water.

Factory is ISO-9001 certified.

1.3 Delivery Storage and Handling

Each unit shall be individually packaged from point of manufacture. Units shall be handled and stored in accordance with the manufacturer's instructions.

Part 2 – PRODUCTS

Equipment

2.1 General

Factory assembled, horizontal blow through type fan coil for furred-in ducted installations. Units shall be completed with water coil(s), fan(s), motor(s), drain pan, filters and all required wiring, collars for ducted units. Unit insulation and unit's drain pan insulation are UL94 compliance.

2.2 42CET/ 42CED Furred-in Units

Base 42CET/CED unit with factory installed plenum section and cleanable filter as shown on equipment drawings. The plenum shall be rear air return. Shall enclose the fan/motor assemblies, and shall be lined with 10mm thick PU insulation 20kg/m³ density and 6.0mm PE insulation 28.6kg/m³ density on the drain pan. Unit shall have a removable panel to provide access to fan/motor assemblies and unit identification label.

2.3 42DC/42DCD Horizontal Base Unit with Plenum for Concealed Installations

Unit has a factory installed, galvanized steel plenum section and one-in permanent filter. The plenum shall be rear return, lined with 12.7mm PU insulation 20kg/m³ and 6.0mm PE insulation 28.6kg/m³ on the drain pan, and include a removable panel to provide access to the fan/motor assembly.

2.4 Fan

Direct driven, double width fan wheels with forward curved blades shall be statically and dynamically balanced. Scrolls and fan wheels shall be constructed of galvanized steel.

2.5 Coils

Drain pan covers entire length and width of coil till the headers. Drain pan inside coated and outside insulated, Standard base unit shall be equipped with a 4-row coil for installation in a 2-pipe system. Coils shall have 7mm copper tubes, aluminium fins bonded to the tubes by mechanical expansion. Each coil shall have a manual air vent and threaded or sweat connections field piping. Working pressure 1.72 Mpa, 0.105mm fin thickness and 0.24mm tube wall thickness.

2.6 Operating Characteristics

A one coil unit installed in a 2-pipe system shall be capable of providing cooling as determined by the operating mode of the central water supply system.

2.7 Electrical Requirements

Standard unit shall operate on 230V±10%, single phase, 60Hz electric power.

2.8 Motor(s)

Fan motors shall be 3-speed, 220/240V, single phase, 60Hz permanent split capacitor type, with ball type bearings and over-sized oil reservoirs to ensure lubrication.

The fan motor(s) shall be equipped with integral automatic temperature reset for motor protection. Motor insulation is Class E and motor is open drip proof type.

2.9 Filter

Permanent washable aluminium filters with 21mm thick and 70% gravimetric efficiency as per European Union EN779 class.

Arrestance or Dust Spot Efficiency	US Ashrae 52.2	European Union EN779 Class
AFI 65% - 70%	MERV 2	G2 65% ≤ Am ≤ 85%

❖ **Drain Pan**

100mm extended drain pan, galvanized or stainless material is available.

❖ **Sandwich Drain Pan**

Two layers of galvanized drain pans with polyurethane insulation in between.

❖ **Insulation**

Fired rated class 0 insulation.

❖ **Casing**

Anti-corrosion powder coated panels. Impressive looks.

❖ **Double Skin Panel**

Anti-corrosion powder coated external panels with in between polyurethane insulation in between.

❖ **Filter**

21mm synthetic media filter. Contact factory if special filter is required.

❖ **Motors**

Class F insulation motor provides reliable operation and suits harder applications. Fan coil units equipped with ECM motor and controller are available as an option.



Carrier International Sdn. Bhd. (3385-T)

Lot 4, Jalan P/6, 43650 Bandar Baru Bangi,
Selangor Darul Ehsan, Malaysia.

Tel: 03-8913 7600